

# Silicon NPN Planar RF Transistor

Electrostatic sensitive device.  
Observe precautions for handling. 

## Applications

RF amplifier up to GHz range specially for wide band antenna amplifier.

## Features

- High power gain
- Low noise figure
- High transition frequency

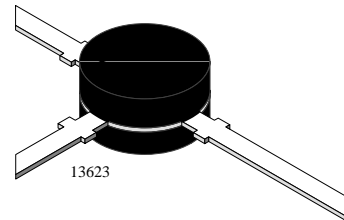
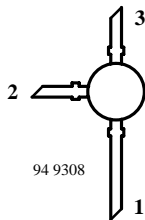

BFR96TS Marking: BFR96TS  
Plastic case (TO 50)  
1 = Collector, 2 = Emitter, 3 = Base

## Absolute Maximum Ratings

$T_{amb} = 25^{\circ}\text{C}$ , unless otherwise specified

Parameter	Test Conditions	Symbol	Value	Unit
Collector-base voltage		$V_{CBO}$	20	V
Collector-emitter voltage		$V_{CEO}$	15	V
Emitter-base voltage		$V_{EBO}$	2.5	V
Collector current		$I_C$	100	mA
Total power dissipation	$T_{amb} \leq 45^{\circ}\text{C}$	$P_{tot}$	700	mW
Junction temperature		$T_j$	150	$^{\circ}\text{C}$
Storage temperature range		$T_{stg}$	-65 to +150	$^{\circ}\text{C}$

## Maximum Thermal Resistance

$T_{amb} = 25^{\circ}\text{C}$ , unless otherwise specified

Parameter	Test Conditions	Symbol	Value	Unit
Junction ambient	on glass fibre printed board (40 x 25 x 1.5) mm <sup>3</sup> plated with 35 $\mu\text{m}$ Cu	$R_{thJA}$	150	K/W

### Electrical DC Characteristics

$T_{amb} = 25^{\circ}\text{C}$ , unless otherwise specified

Parameter	Test Conditions	Symbol	Min	Typ	Max	Unit
Collector cut-off current	$V_{CE} = 20\text{ V}, V_{BE} = 0$	$I_{CES}$			100	$\mu\text{A}$
Collector-base cut-off current	$V_{CB} = 10\text{ V}, I_E = 0$	$I_{CBO}$			100	nA
Emitter-base cut-off current	$V_{EB} = 2.5\text{ V}, I_C = 0$	$I_{EBO}$			10	$\mu\text{A}$
Collector-emitter breakdown voltage	$I_C = 5\text{ mA}, I_B = 0$	$V_{(BR)CEO}$	15			V
DC forward current transfer ratio	$V_{CE} = 10\text{ V}, I_C = 70\text{ mA}$	$h_{FE}$	25	75	150	

### Electrical AC Characteristics

$T_{amb} = 25^{\circ}\text{C}$ , unless otherwise specified

Parameter	Test Conditions	Symbol	Min	Typ	Max	Unit
Transition frequency	$V_{CE} = 10\text{ V}, I_C = 70\text{ mA}, f = 500\text{ MHz}$	$f_T$		5		GHz
Collector-base capacitance	$V_{CB} = 10\text{ V}, f = 1\text{ MHz}$	$C_{cb}$		0.84		pF
Collector-emitter capacitance	$V_{CE} = 10\text{ V}, f = 1\text{ MHz}$	$C_{ce}$		0.4		pF
Emitter-base capacitance	$V_{EB} = 0.5\text{ V}, f = 1\text{ MHz}$	$C_{eb}$		3.5		pF
Noise figure	$V_{CE} = 10\text{ V}, I_C = 70\text{ mA}, Z_S = 50\ \Omega,$ $f = 500\text{ MHz}$	F		3.3		dB
	$V_{CE} = 10\text{ V}, I_C = 70\text{ mA}, Z_S = 50\ \Omega,$ $f = 800\text{ MHz}$	F		4.0		dB
Power gain	$V_{CE} = 10\text{ V}, I_C = 70\text{ mA}, Z_S = 50\ \Omega,$ $Z_L = Z_{Lopt}, f = 800\text{ MHz}$	$G_{pe}$		11.5		dB
Linear output voltage – two tone intermodulation test	$V_{CE} = 10\text{ V}, I_C = 70\text{ mA}, d_{IM} = 60\text{ dB},$ $f_1 = 806\text{ MHz}, f_2 = 810\text{ MHz},$ $Z_S = Z_L = 50\ \Omega$	$V_1 = V_2$		500		mV
Third order intercept point	$V_{CE} = 10\text{ V}, I_C = 70\text{ mA}, f = 800\text{ MHz}$	$IP_3$		37		dBm



**Common Emitter S-Parameters**

$Z_0 = 50 \Omega$ ,  $T_{amb} = 25^\circ C$ , unless otherwise specified

$V_{CE}/V$	$I_C/mA$	f/MHz	S11		S21		S12		S22	
			LIN MAG	ANG	LIN MAG	ANG	LIN MAG	ANG	LIN MAG	ANG
				deg		deg		deg		deg
5	5	100	0.691	-68.6	11.94	137.4	0.044	59.4	0.807	-28.82
		300	0.552	-135.5	6.04	100.7	0.071	46.5	0.521	-45.0
		500	0.518	-162.6	3.85	84.4	0.087	49.4	0.453	-51.6
		800	0.499	173.8	2.47	68.1	0.114	55.7	0.444	-63.0
		1000	0.488	162.5	1.99	59.7	0.136	58.7	0.458	-71.3
		1200	0.477	152.5	1.68	52.3	0.161	60.2	0.478	-79.3
		1500	0.459	139.2	1.37	43.1	0.203	60.5	0.515	-91.2
		1800	0.446	125.8	1.15	34.7	0.247	59.0	0.553	-102.4
	2000	0.427	118.9	1.05	29.9	0.272	57.6	0.577	-109.4	
	10	100	0.538	-92.3	17.08	126.6	0.035	57.6	0.672	-38.9
		300	0.465	-152.7	7.31	94.9	0.060	57.1	0.389	-51.7
		500	0.452	-173.7	4.51	81.7	0.085	61.7	0.341	-57.7
		800	0.444	167.6	2.87	67.7	0.125	64.1	0.343	-69.2
		1000	0.436	157.3	2.31	60.3	0.153	64.0	0.359	-77.5
		1200	0.429	148.6	1.96	53.5	0.182	63.0	0.379	-85.2
		1500	0.413	136.4	1.59	44.7	0.227	60.3	0.415	-96.2
		1800	0.403	124.0	1.35	36.5	0.271	57.0	0.451	-106.4
	2000	0.387	116.8	1.24	31.8	0.294	54.8	0.474	-112.6	
	30	100	0.387	-134.8	22.79	112.9	0.024	65.1	0.467	-52.1
		300	0.401	-172.7	8.44	89.5	0.055	71.8	0.255	-60.2
		500	0.400	174.0	5.13	79.0	0.088	72.5	0.234	-67.0
		800	0.401	160.7	3.25	67.1	0.137	69.9	0.249	-79.7
		1000	0.392	152.5	2.61	60.5	0.170	67.7	0.269	-87.9
		1200	0.390	144.5	2.21	54.2	0.202	64.8	0.291	-95.2
1500		0.375	133.8	1.81	46.1	0.249	60.2	0.326	-105.1	
1800		0.365	121.9	1.54	38.3	0.293	55.6	0.362	-113.7	
2000	0.351	115.4	1.41	33.6	0.315	52.7	0.383	-119.0		

V <sub>CE</sub> /V	I <sub>C</sub> /mA	f/MHz	S11		S21		S12		S22	
			LIN MAG	ANG	LIN MAG	ANG	LIN MAG	ANG	LIN MAG	ANG
				deg		deg		deg		deg
5	50	100	0.370	-150.0	23.94	109.0	0.022	69.6	0.399	-55.7
		300	0.395	-177.8	8.62	87.9	0.055	75.4	0.221	-62.3
		500	0.396	171.3	5.23	78.1	0.090	74.8	0.208	-69.7
		800	0.395	159.1	3.30	66.7	0.140	71.1	0.229	-82.8
		1000	0.389	150.9	2.66	60.2	0.173	68.2	0.250	-90.8
		1200	0.386	143.3	2.25	54.0	0.206	65.1	0.273	-98.0
		1500	0.373	133.2	1.83	45.8	0.253	60.1	0.308	-107.5
		1800	0.363	121.7	1.56	38.2	0.297	55.4	0.343	-115.7
	2000	0.348	115.4	1.43	33.5	0.319	52.5	0.364	-120.8	
	70	100	0.374	-157.4	24.17	107.0	0.021	73.0	0.364	-56.8
		300	0.397	179.7	8.60	87.1	0.055	77.4	0.206	-62.5
		500	0.399	170.0	5.19	77.7	0.090	75.7	0.197	-70.3
		800	0.398	158.4	3.29	66.2	0.141	71.6	0.221	-83.6
		1000	0.394	150.3	2.65	59.8	0.175	68.6	0.243	-91.7
		1200	0.389	143.3	2.24	53.5	0.207	65.3	0.267	-98.8
		1500	0.378	132.8	1.82	45.4	0.255	60.3	0.303	-108.2
1800		0.368	121.7	1.55	37.7	0.299	55.4	0.338	-116.3	
2000	0.355	114.9	1.42	32.9	0.321	52.5	0.359	-121.3		
10	5	100	0.710	-62.3	12.15	140.0	0.036	61.8	0.844	-23.2
		300	0.542	-129.2	6.46	103.2	0.061	48.7	0.591	-36.7
		500	0.497	-157.8	4.14	86.6	0.075	51.4	0.528	-42.4
		800	0.479	177.3	2.66	70.2	0.099	58.2	0.519	-52.7
		1000	0.464	165.3	2.14	61.8	0.118	61.7	0.533	-60.5
		1200	0.454	155.0	1.81	54.5	0.141	63.7	0.550	-68.3
		1500	0.438	141.0	1.45	45.0	0.178	64.5	0.585	-79.8
		1800	0.427	127.6	1.23	36.5	0.219	63.7	0.623	-91.0
	2000	0.410	119.7	1.11	31.8	0.244	62.4	0.646	-98.1	
	10	100	0.544	-83.4	17.99	129.3	0.029	60.1	0.722	-31.2
		300	0.436	-146.3	7.94	96.9	0.052	58.8	0.463	-40.3
		500	0.417	-169.2	4.94	83.4	0.073	63.5	0.419	-45.2
		800	0.410	170.8	3.14	69.6	0.109	66.4	0.419	-55.8
		1000	0.397	160.5	2.52	62.1	0.134	66.8	0.433	-63.6
		1200	0.394	151.1	2.13	55.5	0.160	66.1	0.450	-71.3
		1500	0.384	139.1	1.73	46.6	0.201	63.8	0.483	-82.5
1800		0.372	125.9	1.46	38.1	0.241	61.1	0.520	-93.0	
2000	0.357	118.6	1.33	33.4	0.264	59.0	0.542	-99.6		



V <sub>CE</sub> /V	I <sub>C</sub> /mA	f/MHz	S11		S21		S12		S22	
			LIN MAG	ANG	LIN MAG	ANG	LIN MAG	ANG	LIN MAG	ANG
				deg		deg		deg		deg
10	30	100	0.356	-122.3	24.66	115.3	0.021	66.0	0.525	-40.2
		300	0.351	-167.1	9.31	90.0	0.048	72.5	0.333	-42.5
		500	0.349	178.4	5.65	80.5	0.077	73.6	0.313	-48.0
		800	0.351	164.4	3.59	68.7	0.121	71.6	0.323	-60.0
		1000	0.348	155.5	2.88	62.2	0.150	69.7	0.340	-68.3
		1200	0.343	147.4	2.44	56.0	0.179	67.3	0.358	-76.2
		1500	0.334	136.6	1.97	47.6	0.222	63.2	0.390	-87.2
		1800	0.328	124.7	1.68	39.6	0.262	59.1	0.426	-97.0
		2000	0.312	117.3	1.53	35.0	0.283	56.5	0.447	-103.1
	50	100	0.325	-137.8	26.14	110.8	0.019	69.8	0.457	-41.9
		300	0.337	-172.8	9.52	89.1	0.049	75.9	0.299	-42.2
		500	0.339	174.8	5.78	79.3	0.079	75.7	0.286	-48.2
		800	0.343	162.2	3.65	68.1	0.123	72.6	0.300	-61.0
		1000	0.337	154.3	2.94	61.8	0.153	70.1	0.318	-69.7
		1200	0.334	146.6	2.48	55.6	0.183	67.4	0.338	-77.6
		1500	0.327	136.1	2.02	47.5	0.226	63.0	0.370	-88.5
		1800	0.322	124.1	1.70	39.6	0.267	58.7	0.406	-98.2
	2000	0.311	118.2	1.55	34.6	0.288	55.9	0.428	-104.1	
	70	100	0.323	-145.1	26.39	108.4	0.018	72.0	0.424	-41.8
		300	0.339	-175.6	9.46	88.1	0.049	76.9	0.287	-41.1
		500	0.339	174.1	5.74	78.8	0.079	76.3	0.278	-47.7
		800	0.344	162.0	3.62	67.5	0.124	72.8	0.295	-61.0
		1000	0.341	153.8	2.92	61.1	0.154	70.4	0.313	-69.7
		1200	0.340	146.2	2.46	55.0	0.184	67.6	0.333	-77.6
1500		0.333	135.6	1.99	46.8	0.227	63.0	0.367	-88.7	
1800		0.326	14.2	1.68	39.0	0.268	58.6	0.403	-98.4	
2000		0.318	117.8	1.54	34.0	0.289	55.9	0.425	-104.4	

## Typical Characteristics ( $T_{amb} = 25^{\circ}\text{C}$ unless otherwise specified)

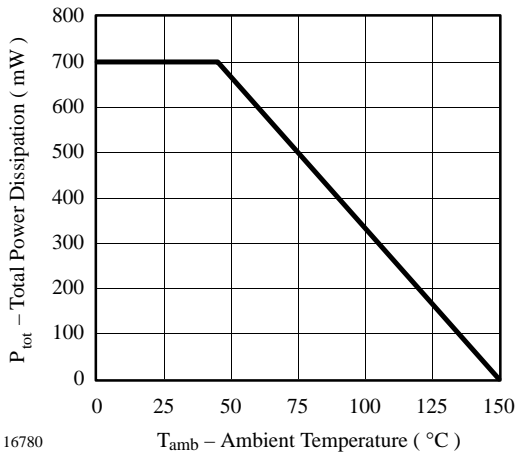

Figure 1. Total Power Dissipation vs. Ambient Temperature

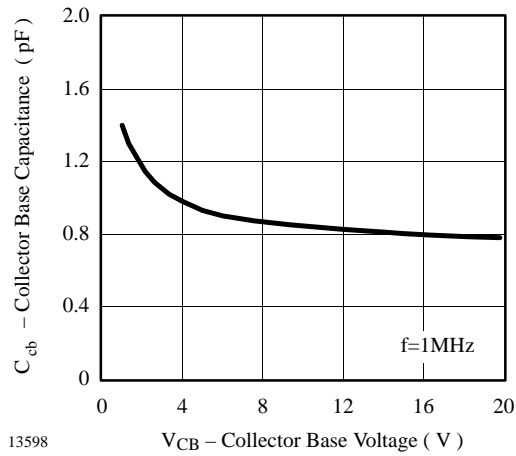

Figure 3. Collector Base Capacitance vs. Collector Base Voltage

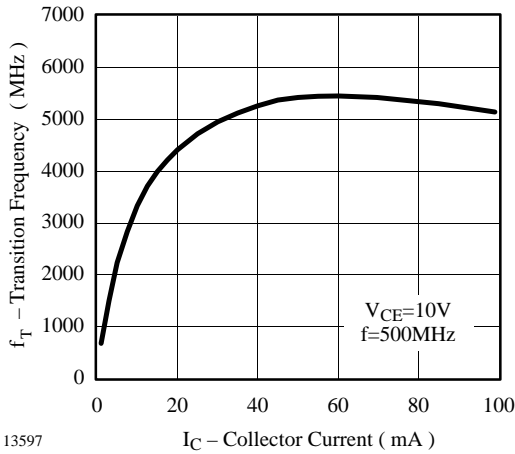

Figure 2. Transition Frequency vs. Collector Current

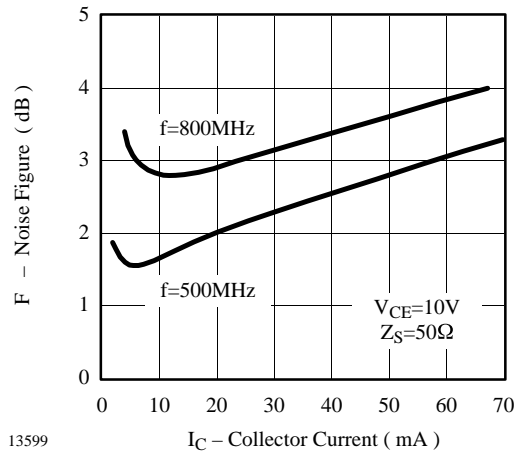

Figure 4. Noise Figure vs. Collector Current

$V_{CE} = 10 \text{ V}$ ,  $I_C = 70 \text{ mA}$ ,  $Z_0 = 50 \Omega$

$S_{11}$

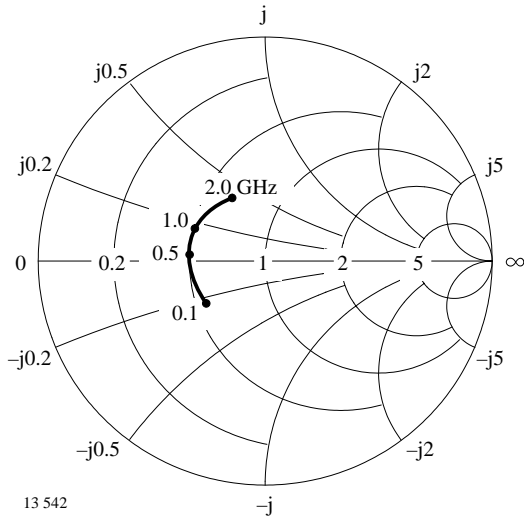

Figure 5. Input reflection coefficient

$S_{12}$

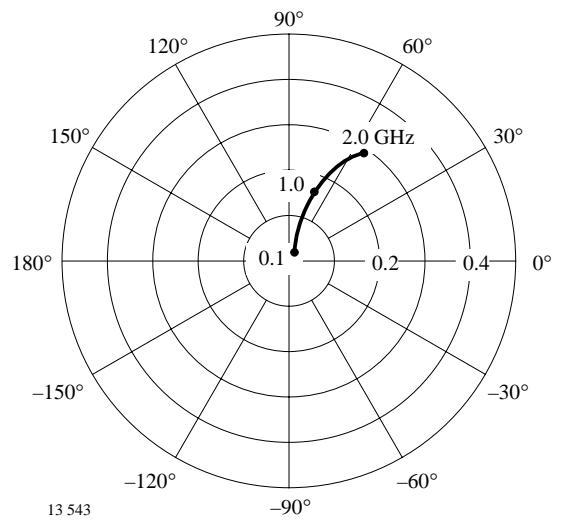

Figure 7. Reverse transmission coefficient

$S_{21}$

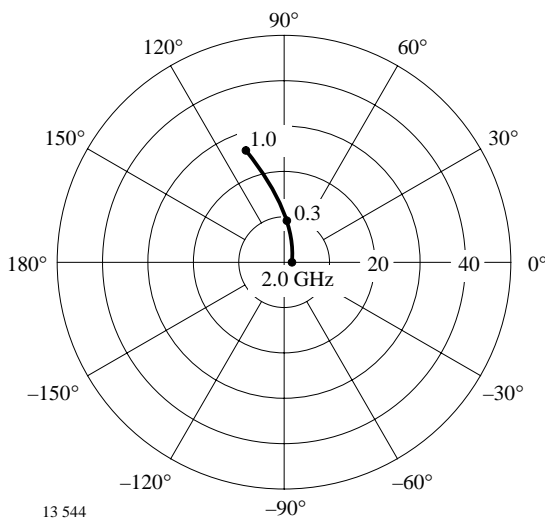

Figure 6. Forward transmission coefficient

$S_{22}$

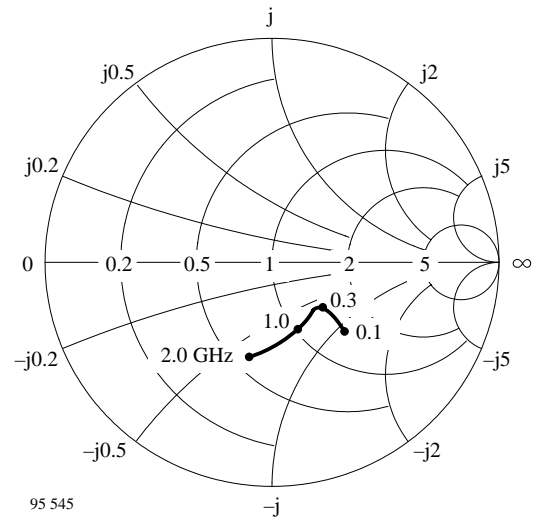
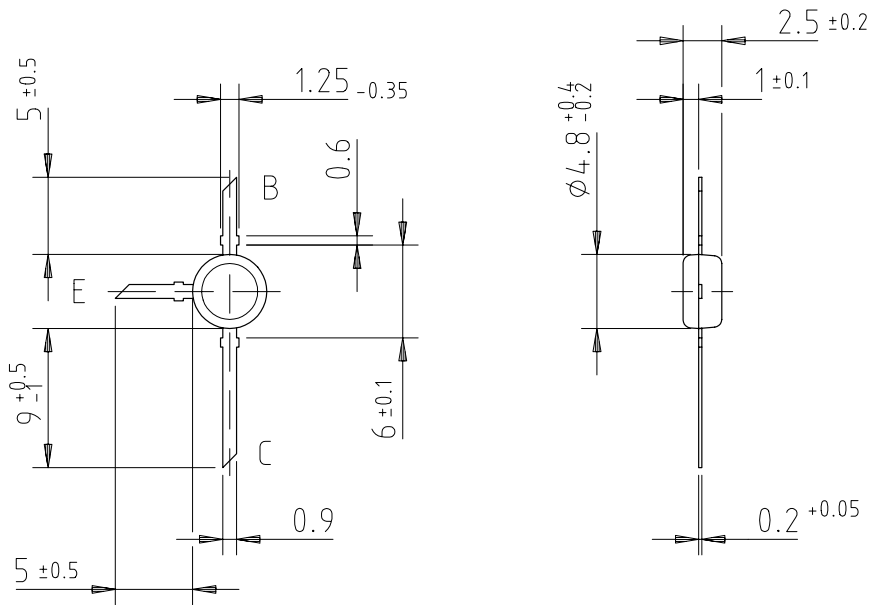
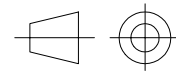

Figure 8. Output reflection coefficient

## Dimensions of BFR96TS in mm



96 12244



technical drawings  
according to DIN  
specifications



## Ozone Depleting Substances Policy Statement

It is the policy of **Vishay Semiconductor GmbH** to

1. Meet all present and future national and international statutory requirements.
2. Regularly and continuously improve the performance of our products, processes, distribution and operating systems with respect to their impact on the health and safety of our employees and the public, as well as their impact on the environment.

It is particular concern to control or eliminate releases of those substances into the atmosphere which are known as ozone depleting substances (ODSs).

The Montreal Protocol (1987) and its London Amendments (1990) intend to severely restrict the use of ODSs and forbid their use within the next ten years. Various national and international initiatives are pressing for an earlier ban on these substances.

**Vishay Semiconductor GmbH** has been able to use its policy of continuous improvements to eliminate the use of ODSs listed in the following documents.

1. Annex A, B and list of transitional substances of the Montreal Protocol and the London Amendments respectively
2. Class I and II ozone depleting substances in the Clean Air Act Amendments of 1990 by the Environmental Protection Agency (EPA) in the USA
3. Council Decision 88/540/EEC and 91/690/EEC Annex A, B and C (transitional substances) respectively.

**Vishay Semiconductor GmbH** can certify that our semiconductors are not manufactured with ozone depleting substances and do not contain such substances.

**We reserve the right to make changes to improve technical design and may do so without further notice.**

Parameters can vary in different applications. All operating parameters must be validated for each customer application by the customer. Should the buyer use Vishay-Telefunken products for any unintended or unauthorized application, the buyer shall indemnify Vishay-Telefunken against all claims, costs, damages, and expenses, arising out of, directly or indirectly, any claim of personal damage, injury or death associated with such unintended or unauthorized use.

Vishay Semiconductor GmbH, P.O.B. 3535, D-74025 Heilbronn, Germany  
Telephone: 49 (0) 7131 67 2831, Fax number: 49 (0) 7131 67 2423