

## Silicon NPN Planar RF Transistor

Electrostatic sensitive device.  
Observe precautions for handling.



### Applications

RF amplifier up to GHz range specially for wide band antenna amplifier.

### Features

- High power gain
- Low noise figure
- High transition frequency

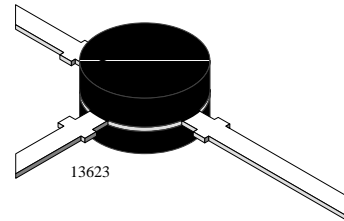
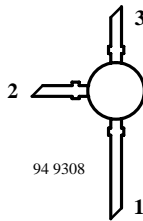

BFR90A Marking: BFR90A  
Plastic case (TO 50)  
1 = Collector, 2 = Emitter, 3 = Base

### Absolute Maximum Ratings

$T_{amb} = 25^{\circ}\text{C}$ , unless otherwise specified

| Parameter                 | Test Conditions                   | Symbol    | Value       | Unit               |
|---------------------------|-----------------------------------|-----------|-------------|--------------------|
| Collector-base voltage    |                                   | $V_{CBO}$ | 20          | V                  |
| Collector-emitter voltage |                                   | $V_{CEO}$ | 15          | V                  |
| Emitter-base voltage      |                                   | $V_{EBO}$ | 2           | V                  |
| Collector current         |                                   | $I_C$     | 30          | mA                 |
| Total power dissipation   | $T_{amb} \leq 60^{\circ}\text{C}$ | $P_{tot}$ | 300         | mW                 |
| Junction temperature      |                                   | $T_j$     | 150         | $^{\circ}\text{C}$ |
| Storage temperature range |                                   | $T_{stg}$ | -65 to +150 | $^{\circ}\text{C}$ |

### Maximum Thermal Resistance

$T_{amb} = 25^{\circ}\text{C}$ , unless otherwise specified

| Parameter        | Test Conditions  | Symbol     | Value | Unit |
|------------------|--|------------|-------|------|
| Junction ambient | on glass fibre printed board (40 x 25 x 1.5) mm <sup>3</sup> plated with 35 $\mu\text{m}$ Cu | $R_{thJA}$ | 300   | K/W  |

### Electrical DC Characteristics

$T_{amb} = 25^{\circ}\text{C}$ , unless otherwise specified

| Parameter                           | Test Conditions                            | Symbol        | Min | Typ | Max | Unit          |
|-------------------------------------|--|---------------|-----|-----|-----|---------------|
| Collector cut-off current           | $V_{CE} = 20\text{ V}, V_{BE} = 0$         | $I_{CES}$     |     |     | 100 | $\mu\text{A}$ |
| Collector-base cut-off current      | $V_{CB} = 15\text{ V}, I_E = 0$            | $I_{CBO}$     |     |     | 100 | nA            |
| Emitter-base cut-off current        | $V_{EB} = 2\text{ V}, I_C = 0$             | $I_{EBO}$     |     |     | 10  | $\mu\text{A}$ |
| Collector-emitter breakdown voltage | $I_C = 1\text{ mA}, I_B = 0$               | $V_{(BR)CEO}$ | 15  |     |     | V             |
| DC forward current transfer ratio   | $V_{CE} = 10\text{ V}, I_C = 14\text{ mA}$ | $h_{FE}$      | 50  | 100 | 150 |               |

### Electrical AC Characteristics

$T_{amb} = 25^{\circ}\text{C}$ , unless otherwise specified

| Parameter   | Test Conditions   | Symbol      | Min | Typ  | Max | Unit |
|---|---|-------------|-----|------|-----|------|
| Transition frequency                                  | $V_{CE} = 10\text{ V}, I_C = 14\text{ mA}, f = 500\text{ MHz}$  | $f_T$       |     | 6    |     | GHz  |
| Collector-base capacitance                            | $V_{CB} = 10\text{ V}, f = 1\text{ MHz}$  | $C_{cb}$    |     | 0.3  |     | pF   |
| Collector-emitter capacitance                         | $V_{CE} = 10\text{ V}, f = 1\text{ MHz}$  | $C_{ce}$    |     | 0.25 |     | pF   |
| Emitter-base capacitance                              | $V_{EB} = 0.5\text{ V}, f = 1\text{ MHz}$   | $C_{eb}$    |     | 0.9  |     | pF   |
| Noise figure  | $V_{CE} = 10\text{ V}, I_C = 2\text{ mA}, f = 800\text{ MHz}, Z_S = 50\ \Omega$   | F           |     | 1.8  |     | dB   |
| Power gain  | $V_{CE} = 10\text{ V}, I_C = 14\text{ mA}, Z_L = Z_{Lopt}, f = 800\text{ MHz}$  | $G_{pe}$    |     | 16   |     | dB   |
| Linear output voltage – two tone intermodulation test | $V_{CE} = 10\text{ V}, I_C = 14\text{ mA}, d_{IM} = 60\text{ dB}, f_1 = 806\text{ MHz}, f_2 = 810\text{ MHz}, Z_S = Z_L = 50\ \Omega$ | $V_1 = V_2$ |     | 120  |     | mV   |
| Third order intercept point                           | $V_{CE} = 10\text{ V}, I_C = 14\text{ mA}, f = 800\text{ MHz}$  | $IP_3$      |     | 24   |     | dBm  |



### Common Emitter S-Parameters

$Z_0 = 50 \Omega$ ,  $T_{amb} = 25^\circ\text{C}$ , unless otherwise specified

| $V_{CE}/V$ | $I_C/mA$ | f/MHz | S11     |        | S21     |       | S12     |       | S22     |       |
|------------|----------|-------|---------|--------|---------|-------|---------|-------|---------|-------|
|            |          |       | LIN MAG | ANG    | LIN MAG | ANG   | LIN MAG | ANG   | LIN MAG | ANG   |
|            |          |       |         | deg    |         | deg   |         | deg   |         | deg   |
| 5          | 2        | 100   | 0.90    | -17.7  | 6.25    | 165.4 | 0.02    | 81.1  | 0.98    | -6.8  |
|            |          | 300   | 0.80    | -50.4  | 5.51    | 140.9 | 0.05    | 65.5  | 0.91    | -18.2 |
|            |          | 500   | 0.67    | -78.1  | 4.66    | 121.6 | 0.07    | 56.7  | 0.84    | -25.8 |
|            |          | 800   | 0.52    | -111.2 | 3.56    | 99.9  | 0.08    | 51.2  | 0.77    | -33.8 |
|            |          | 1000  | 0.45    | -128.8 | 2.99    | 89.0  | 0.09    | 51.0  | 0.75    | -38.4 |
|            |          | 1200  | 0.40    | -144.1 | 2.58    | 80.3  | 0.10    | 52.1  | 0.74    | -42.7 |
|            |          | 1500  | 0.34    | -164.2 | 2.11    | 69.3  | 0.11    | 54.6  | 0.74    | -49.4 |
|            |          | 1800  | 0.30    | 176.6  | 1.80    | 59.3  | 0.12    | 57.8  | 0.75    | -56.3 |
|            | 2000     | 0.28  | 165.9   | 1.64   | 54.2    | 0.13  | 59.4    | 0.76  | -61.0   |       |
|            | 5        | 100   | 0.77    | -27.0  | 13.24   | 156.9 | 0.02    | 76.2  | 0.95    | -10.9 |
|            |          | 300   | 0.56    | -69.4  | 9.72    | 125.0 | 0.04    | 63.9  | 0.79    | -23.5 |
|            |          | 500   | 0.41    | -97.4  | 7.01    | 106.7 | 0.05    | 61.8  | 0.70    | -28.5 |
|            |          | 800   | 0.30    | -126.9 | 4.76    | 89.9  | 0.07    | 63.5  | 0.65    | -34.1 |
|            |          | 1000  | 0.26    | -142.7 | 3.89    | 81.8  | 0.08    | 64.6  | 0.64    | -38.3 |
|            |          | 1200  | 0.24    | -155.8 | 3.29    | 75.1  | 0.10    | 65.7  | 0.63    | -42.5 |
|            |          | 1500  | 0.21    | -174.3 | 2.67    | 66.5  | 0.12    | 66.2  | 0.64    | -49.3 |
|            |          | 1800  | 0.19    | 167.7  | 2.27    | 58.1  | 0.14    | 66.0  | 0.66    | -56.2 |
|            | 2000     | 0.18  | 158.7   | 2.06   | 53.8    | 0.16  | 65.5    | 0.67  | -60.6   |       |
|            | 10       | 100   | 0.61    | -38.3  | 20.89   | 147.5 | 0.02    | 74.8  | 0.89    | -15.0 |
|            |          | 300   | 0.36    | -85.3  | 12.29   | 113.4 | 0.03    | 67.7  | 0.68    | -24.6 |
|            |          | 500   | 0.26    | -111.7 | 8.10    | 98.2  | 0.05    | 69.4  | 0.61    | -27.5 |
|            |          | 800   | 0.20    | -139.9 | 5.28    | 84.9  | 0.07    | 71.4  | 0.58    | -32.8 |
|            |          | 1000  | 0.18    | -154.3 | 4.28    | 78.0  | 0.08    | 71.8  | 0.58    | -37.0 |
|            |          | 1200  | 0.17    | -166.5 | 3.61    | 72.3  | 0.10    | 71.6  | 0.58    | -41.5 |
| 1500       |          | 0.16  | 177.7   | 2.91   | 64.7    | 0.12  | 70.3    | 0.59  | -48.7   |       |
| 1800       |          | 0.14  | 160.4   | 2.48   | 57.1    | 0.15  | 68.7    | 0.61  | -55.7   |       |
| 2000       | 0.14     | 153.6 | 2.26    | 53.1   | 0.17    | 67.5  | 0.62    | -60.4 |         |       |



| V <sub>CE</sub> /V | I <sub>C</sub> /mA | f/MHz | S11        |        | S21        |       | S12        |       | S22        |       |
|--------------------|--------------------|-------|------------|--------|------------|-------|------------|-------|------------|-------|
|                    |                    |       | LIN<br>MAG | ANG    | LIN<br>MAG | ANG   | LIN<br>MAG | ANG   | LIN<br>MAG | ANG   |
|                    |                    |       |            | deg    |            | deg   |            | deg   |            | deg   |
| 5                  | 14                 | 100   | 0.51       | -44.8  | 24.51      | 142.5 | 0.01       | 74.5  | 0.86       | -16.7 |
|                    |                    | 300   | 0.28       | -93.9  | 13.01      | 108.9 | 0.03       | 71.0  | 0.65       | -24.1 |
|                    |                    | 500   | 0.20       | -120.2 | 8.36       | 95.3  | 0.05       | 72.9  | 0.59       | -26.2 |
|                    |                    | 800   | 0.17       | -147.3 | 5.40       | 83.0  | 0.07       | 74.0  | 0.57       | -31.8 |
|                    |                    | 1000  | 0.15       | -160.1 | 4.36       | 76.6  | 0.08       | 74.0  | 0.57       | -36.2 |
|                    |                    | 1200  | 0.15       | -172.1 | 3.69       | 71.3  | 0.10       | 73.4  | 0.57       | -40.7 |
|                    |                    | 1500  | 0.14       | 172.8  | 2.98       | 63.9  | 0.13       | 71.7  | 0.58       | -48.0 |
|                    |                    | 1800  | 0.13       | 155.7  | 2.52       | 56.5  | 0.15       | 69.8  | 0.60       | -55.1 |
|                    | 2000               | 0.13  | 147.1      | 2.29   | 52.8       | 0.17  | 68.3       | 0.61  | -59.8      |       |
|                    | 20                 | 100   | 0.41       | -53.2  | 27.71      | 137.2 | 0.01       | 74.0  | 0.82       | -18.0 |
|                    |                    | 300   | 0.22       | -105.4 | 13.38      | 104.9 | 0.03       | 74.1  | 0.62       | -22.9 |
|                    |                    | 500   | 0.17       | -131.2 | 8.45       | 92.6  | 0.04       | 75.6  | 0.58       | -24.8 |
|                    |                    | 800   | 0.15       | -156.4 | 5.41       | 81.3  | 0.07       | 76.1  | 0.56       | -30.7 |
|                    |                    | 1000  | 0.14       | -170.4 | 4.36       | 75.2  | 0.09       | 75.4  | 0.56       | -35.3 |
|                    |                    | 1200  | 0.14       | 177.4  | 3.68       | 69.8  | 0.10       | 74.5  | 0.57       | -40.0 |
|                    |                    | 1500  | 0.14       | 164.4  | 2.96       | 62.5  | 0.13       | 72.5  | 0.58       | -47.3 |
|                    |                    | 1800  | 0.14       | 147.5  | 2.51       | 55.4  | 0.15       | 70.4  | 0.59       | -54.5 |
|                    | 2000               | 0.13  | 141.0      | 2.28   | 51.5       | 0.17  | 68.8       | 0.60  | -59.3      |       |
|                    | 30                 | 100   | 0.30       | -67.7  | 29.72      | 131.4 | 0.01       | 74.3  | 0.78       | -18.4 |
|                    |                    | 300   | 0.19       | -125.3 | 13.17      | 101.2 | 0.03       | 76.3  | 0.61       | -20.7 |
|                    |                    | 500   | 0.16       | -149.8 | 8.19       | 90.0  | 0.04       | 78.0  | 0.58       | -22.8 |
|                    |                    | 800   | 0.16       | -171.3 | 5.23       | 79.2  | 0.07       | 77.8  | 0.57       | -29.0 |
|                    |                    | 1000  | 0.16       | 177.6  | 4.21       | 73.3  | 0.08       | 77.1  | 0.57       | -33.9 |
|                    |                    | 1200  | 0.16       | 167.5  | 3.54       | 68.2  | 0.10       | 76.0  | 0.58       | -38.6 |
| 1500               |                    | 0.16  | 156.2      | 2.85   | 60.9       | 0.126 | 73.9       | 0.59  | -46.1      |       |
| 1800               |                    | 0.16  | 139.1      | 2.41   | 53.8       | 0.15  | 71.7       | 0.61  | -53.5      |       |
| 2000               | 0.16               | 133.3 | 2.19       | 49.9   | 0.17       | 70.0  | 0.62       | -58.3 |            |       |



| V <sub>CE</sub> /V | I <sub>C</sub> /mA | f/MHz | S11     |        | S21     |       | S12     |      | S22     |       |
|--------------------|--------------------|-------|---------|--------|---------|-------|---------|------|---------|-------|
|                    |                    |       | LIN MAG | ANG    | LIN MAG | ANG   | LIN MAG | ANG  | LIN MAG | ANG   |
|                    |                    |       |         | deg    |         | deg   |         | deg  |         | deg   |
| 10                 | 2                  | 100   | 0.92    | -16.7  | 6.23    | 166.0 | 0.01    | 80.6 | 0.98    | -5.7  |
|                    |                    | 300   | 0.87    | -47.6  | 5.55    | 142.1 | 0.03    | 67.1 | 0.93    | -15.5 |
|                    |                    | 500   | 0.69    | -74.0  | 4.75    | 123.3 | 0.05    | 58.8 | 0.87    | -22.2 |
|                    |                    | 800   | 0.53    | -106.0 | 3.67    | 101.9 | 0.06    | 54.1 | 0.82    | -29.5 |
|                    |                    | 1000  | 0.45    | -122.8 | 3.10    | 90.9  | 0.07    | 54.4 | 0.80    | -33.9 |
|                    |                    | 1200  | 0.39    | -138.0 | 2.67    | 82.3  | 0.08    | 56.0 | 0.79    | -38.0 |
|                    |                    | 1500  | 0.33    | -158.2 | 2.19    | 71.2  | 0.09    | 59.8 | 0.80    | -44.3 |
|                    |                    | 1800  | 0.29    | -177.6 | 1.87    | 61.2  | 0.10    | 63.6 | 0.81    | -50.8 |
|                    |                    | 2000  | 0.27    | 172.2  | 1.70    | 56.1  | 0.11    | 65.5 | 0.83    | -55.3 |
|                    | 5                  | 100   | 0.80    | -24.7  | 13.17   | 158.0 | 0.01    | 77.5 | 0.96    | -8.8  |
|                    |                    | 300   | 0.58    | -63.9  | 9.89    | 126.8 | 0.03    | 65.7 | 0.83    | -19.3 |
|                    |                    | 500   | 0.43    | -89.9  | 7.21    | 108.5 | 0.04    | 63.5 | 0.76    | -23.7 |
|                    |                    | 800   | 0.30    | -117.6 | 4.94    | 91.6  | 0.06    | 65.9 | 0.72    | -29.2 |
|                    |                    | 1000  | 0.26    | -132.1 | 4.04    | 83.4  | 0.07    | 67.5 | 0.71    | -33.2 |
|                    |                    | 1200  | 0.22    | -145.9 | 3.42    | 76.8  | 0.08    | 69.1 | 0.71    | -37.2 |
|                    |                    | 1500  | 0.19    | -163.0 | 2.77    | 68.0  | 0.10    | 70.2 | 0.72    | -43.6 |
|                    |                    | 1800  | 0.17    | 177.9  | 2.36    | 59.8  | 0.12    | 70.7 | 0.79    | -50.3 |
|                    |                    | 2000  | 0.15    | 168.8  | 2.15    | 55.6  | 0.13    | 70.4 | 0.75    | -54.7 |
|                    | 10                 | 100   | 0.65    | -34.2  | 20.73   | 149.1 | 0.01    | 74.8 | 0.92    | -11.8 |
|                    |                    | 300   | 0.39    | -77.0  | 12.60   | 115.1 | 0.03    | 68.7 | 0.75    | -19.8 |
|                    |                    | 500   | 0.27    | -99.8  | 8.38    | 99.9  | 0.04    | 70.7 | 0.69    | -22.6 |
|                    |                    | 800   | 0.19    | -124.7 | 5.50    | 86.3  | 0.06    | 73.2 | 0.67    | -27.8 |
|                    |                    | 1000  | 0.17    | -138.1 | 4.45    | 79.4  | 0.07    | 74.3 | 0.67    | -31.9 |
|                    |                    | 1200  | 0.15    | -151.4 | 3.76    | 74.0  | 0.08    | 74.2 | 0.67    | -36.2 |
|                    |                    | 1500  | 0.13    | -167.7 | 3.04    | 66.4  | 0.11    | 74.1 | 0.68    | -42.7 |
|                    |                    | 1800  | 0.18    | 174.5  | 2.58    | 58.8  | 0.13    | 73.1 | 0.70    | -49.5 |
|                    |                    | 2000  | 0.11    | 165.6  | 2.35    | 54.8  | 0.14    | 72.3 | 0.72    | -53.9 |
|                    | 14                 | 100   | 0.56    | -39.9  | 24.49   | 144.2 | 0.01    | 74.3 | 0.89    | -13.1 |
|                    |                    | 300   | 0.31    | -83.1  | 13.40   | 110.5 | 0.03    | 71.4 | 0.72    | -19.3 |
|                    |                    | 500   | 0.21    | -104.9 | 8.66    | 96.8  | 0.04    | 74.1 | 0.67    | -21.6 |
|                    |                    | 800   | 0.16    | -129.3 | 5.62    | 84.4  | 0.06    | 76.0 | 0.66    | -26.9 |
|                    |                    | 1000  | 0.14    | -142.2 | 4.55    | 78.0  | 0.07    | 76.3 | 0.66    | -31.0 |
|                    |                    | 1200  | 0.13    | -155.9 | 3.83    | 72.7  | 0.08    | 76.1 | 0.66    | -35.5 |
|                    |                    | 1500  | 0.12    | -170.8 | 3.10    | 65.4  | 0.10    | 75.3 | 0.68    | -42.2 |
|                    |                    | 1800  | 0.11    | 169.7  | 2.63    | 58.1  | 0.13    | 74.0 | 0.70    | -49.1 |
|                    |                    | 2000  | 0.11    | 162.3  | 2.39    | 54.3  | 0.14    | 73.0 | 0.71    | -53.5 |

## Typical Characteristics ( $T_{amb} = 25^{\circ}\text{C}$ unless otherwise specified)

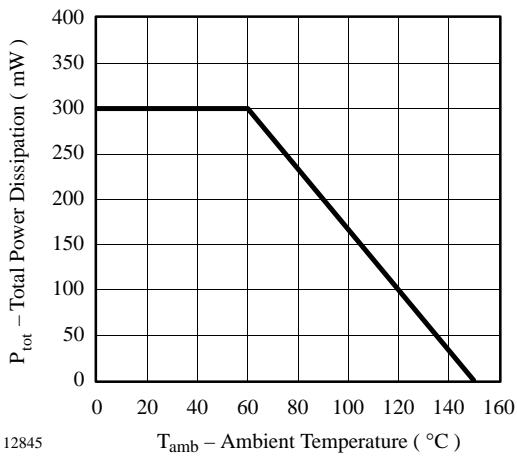

Figure 1. Total Power Dissipation vs. Ambient Temperature

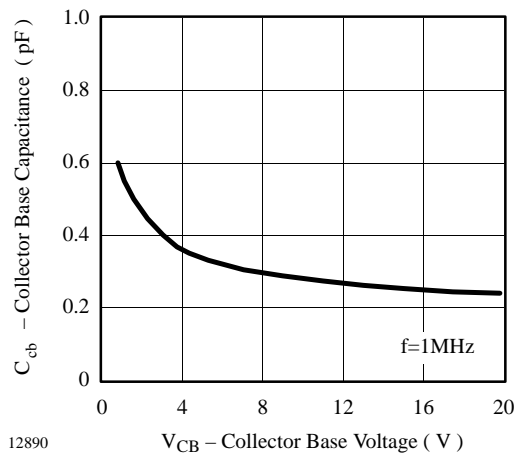

Figure 3. Collector Base Capacitance vs. Collector Base Voltage

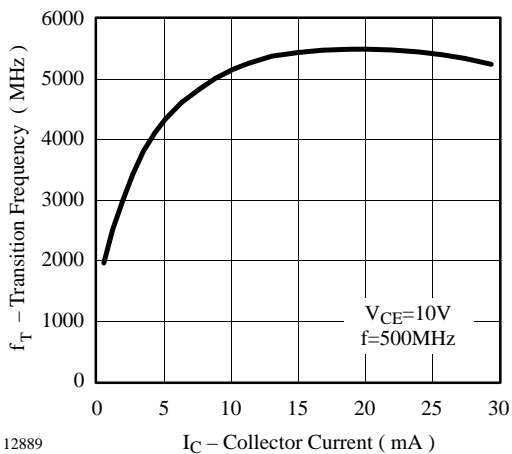

Figure 2. Transition Frequency vs. Collector Current

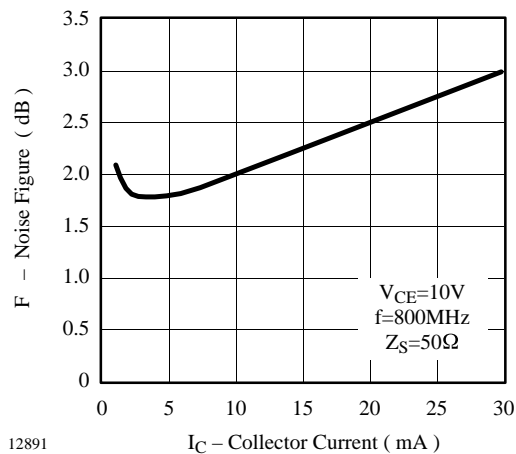

Figure 4. Noise Figure vs. Collector Current

$V_{CE} = 10 \text{ V}$ ,  $I_C = 14 \text{ mA}$ ,  $Z_0 = 50 \Omega$

$S_{11}$

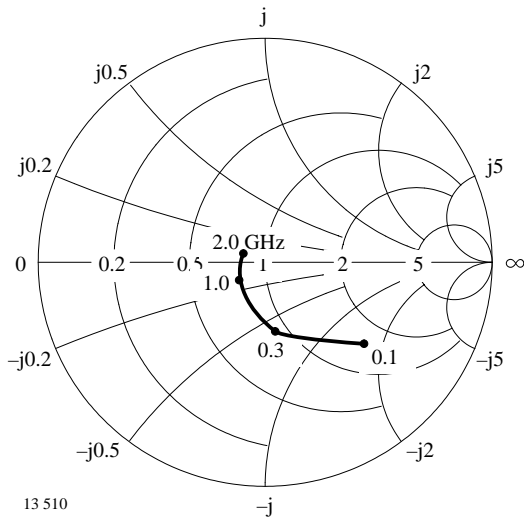

Figure 5. Input reflection coefficient

$S_{12}$

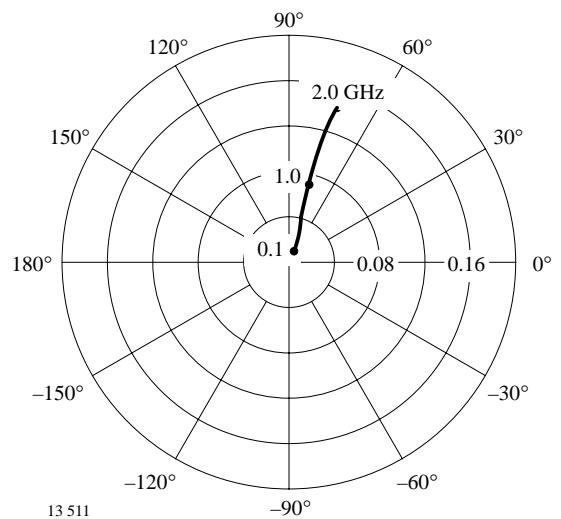

Figure 7. Reverse transmission coefficient

$S_{21}$

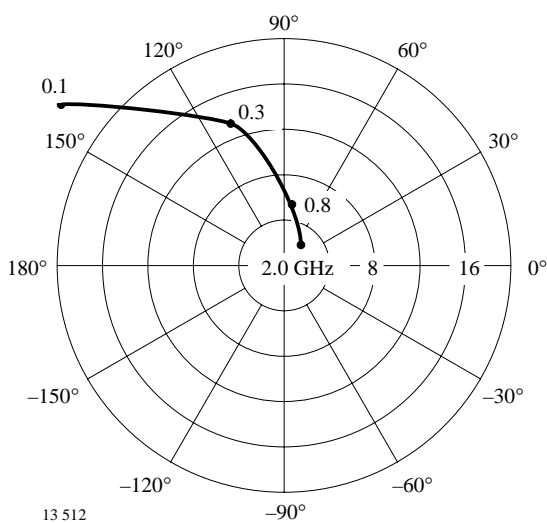

Figure 6. Forward transmission coefficient

$S_{22}$

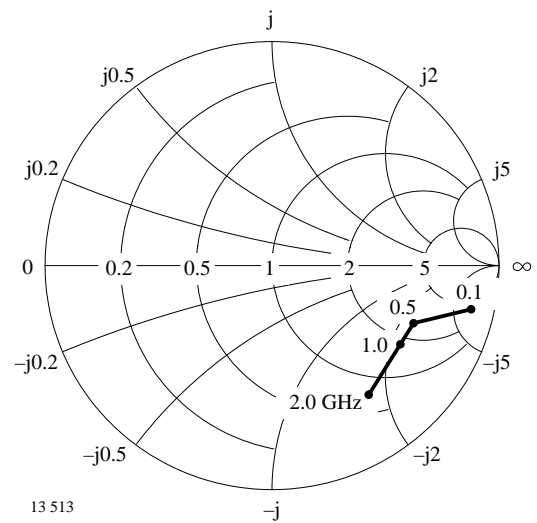
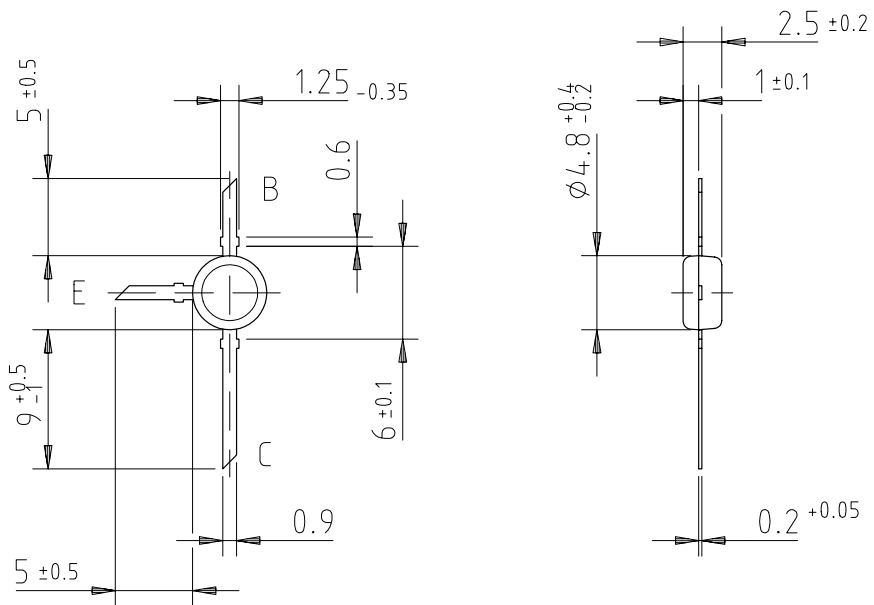
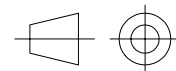

Figure 8. Output reflection coefficient

## Dimensions of BFR90A in mm



96 12244



technical drawings  
according to DIN  
specifications



## Ozone Depleting Substances Policy Statement

It is the policy of **Vishay Semiconductor GmbH** to

1. Meet all present and future national and international statutory requirements.
2. Regularly and continuously improve the performance of our products, processes, distribution and operating systems with respect to their impact on the health and safety of our employees and the public, as well as their impact on the environment.

It is particular concern to control or eliminate releases of those substances into the atmosphere which are known as ozone depleting substances (ODSs).

The Montreal Protocol (1987) and its London Amendments (1990) intend to severely restrict the use of ODSs and forbid their use within the next ten years. Various national and international initiatives are pressing for an earlier ban on these substances.

**Vishay Semiconductor GmbH** has been able to use its policy of continuous improvements to eliminate the use of ODSs listed in the following documents.

1. Annex A, B and list of transitional substances of the Montreal Protocol and the London Amendments respectively
2. Class I and II ozone depleting substances in the Clean Air Act Amendments of 1990 by the Environmental Protection Agency (EPA) in the USA
3. Council Decision 88/540/EEC and 91/690/EEC Annex A, B and C (transitional substances) respectively.

**Vishay Semiconductor GmbH** can certify that our semiconductors are not manufactured with ozone depleting substances and do not contain such substances.

**We reserve the right to make changes to improve technical design and may do so without further notice.**

Parameters can vary in different applications. All operating parameters must be validated for each customer application by the customer. Should the buyer use Vishay-Telefunken products for any unintended or unauthorized application, the buyer shall indemnify Vishay-Telefunken against all claims, costs, damages, and expenses, arising out of, directly or indirectly, any claim of personal damage, injury or death associated with such unintended or unauthorized use.

Vishay Semiconductor GmbH, P.O.B. 3535, D-74025 Heilbronn, Germany  
Telephone: 49 (0)7131 67 2831, Fax number: 49 (0)7131 67 2423